

Support System for Safe Driving

— A Step Toward ITS Autonomous Driving —

Jiro Takezaki
 Nobuyuki Ueki
 Toshimichi Minowa
 Hiroshi Kondoh, Ph.D.

OVERVIEW: An adaptive cruise control (ACC) system is intended to reduce driver fatigue by automatically controlling the distance to the vehicle in front. A typical system now being offered by automobile manufacturers uses a radar to measure the distance to the vehicle in front and controls the engine, transmission and brakes so as to maintain a safe distance between vehicles. Currently, this system is assumed to be used primarily on limited-access highways. In the future, however, with improved functionality and performance and construction of the required infrastructure, this system is expected to be used in a wider range of circumstances, including city roads, to achieve an even safer driving environment. Hitachi, Ltd. positions the ACC system as one of the key systems of a driving safety support system and towards realizing a system that has high performance and advance functions, we have been developing driving environment sensing technology and driving control technology.

INTRODUCTION

THE number of deaths in Japan from automobile accidents is declining due to the efforts of automobile manufacturers to improve the safety of vehicles, but the number of accidents is on an increasing trend.

The results of various analyses of traffic accidents show that human factors account for a large proportion of the causes.

Driving an automobile involves being aware of the driving environment, making judgments, and operating

the vehicle. The “driving safety support system” provides assistance in those three elements for safe driving. Hitachi, Ltd. has been conducting research and development on the infrastructure of this support system from the automobile side.

Here, we describe the trend in driving safety support system R&D, driving environment sensing technology, which is equivalent to human eyes, and vehicle driving control technology, as well as their future evolution.

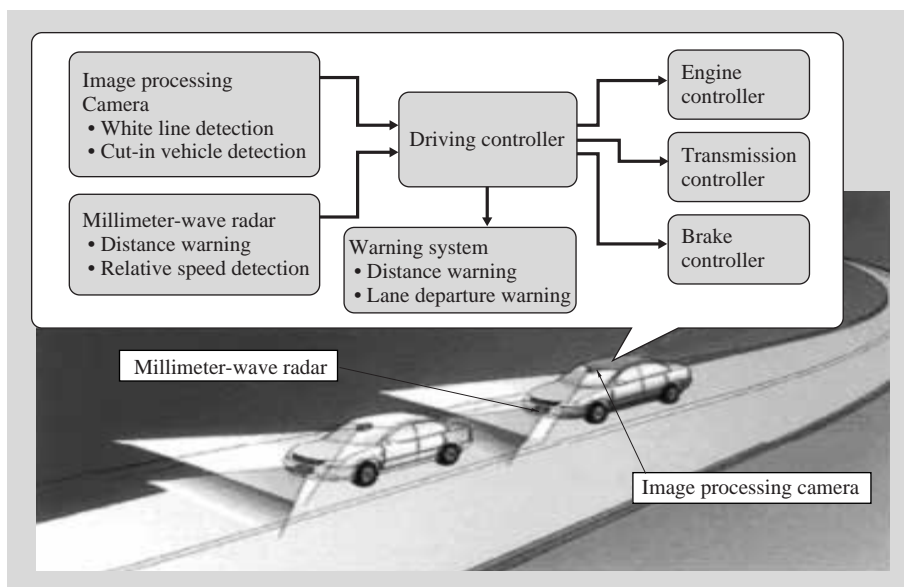

Fig. 1— Driving Safety Support System.

To reduce the burden on the driver of an automobile, various “driving support systems” are being developed. A typical example of such systems is a system for sensing the environment in front of the vehicle and appropriately controlling the distance to the vehicle in front. In future, advances in driving environment-sensing technology are expected to realize support systems that provide even greater safety and convenience.

TRENDS IN DRIVING SAFETY SUPPORT SYSTEM R&D

The System Evolution Process

The concept behind intelligent transport systems (ITS) is broadening. Regarding the automobile and the road as a single system, ITS attempts to make automobile driving safe, ease traffic congestion, and protect the environment. The position of the automobile in ITS is the advanced safety vehicle (ASV), which is a mobile unit for realizing efficient driving in safety and comfort, and R&D is in progress at various companies with the aim of popular use in the beginning of the 21st century.

The extreme form of ASV can be considered as “automatic driving.” To reach that, however, various problems must be overcome.

The anticipated evolution toward automatic driving is shown in Fig. 2. At the current point in time, adaptive cruise control (ACC), which can provide electronic control by employing laser radar or millimeter-wave radar for sensing the distance between vehicles, can be said to be at the beginning stage of popular use.

It is predicted that lane keeping control systems, which control steering on the basis of driving lane recognition results, will come into popular use. It is also expected that advanced driving support systems that make use of information from navigation systems and the infrastructure will appear in the future as a further step toward automatic driving.

Overview of the Technology

The elemental technologies that constitute the driving safety support system are (1) driving-environment sensing technology, (2) driving control technology and (3) actuator technology (Fig. 3).

Driving environment sensing technology senses

various types of obstacles on the road, including automobiles, road shape and road surface conditions. For sensing obstacles on the road surface, radar has been studied and some products are coming out. Laser radar products have long been on the market, but they suffer from low detection capability under weather conditions such as rain and fog, so radio-wave radar systems are also being actively developed by various companies around the world.

Radar-based obstacle detection methods are expected to be implemented, but recognition of road shape is a difficult problem. Because of that difficulty, other methods of driving lane recognition are being studied by various companies, such as embedding nail-like objects in the center of the lane and using cameras to detect the lane marking lines.

The embedded nail methods include magnetic methods and radio methods. The latter features the ability to transmit information.

The camera methods, on the other hand, can be used with existing infrastructure (i.e., lane marking lines), and so can be implemented relatively quickly.

Concerning the sensing of road surface conditions, early detection of the circumstances to the front of the vehicle is necessary, but it is difficult to achieve that early detection by the automobile alone. It is therefore desirable to have information provided by the infrastructure.

Driving control technology means methods of controlling the running, turning and stopping of the vehicle based on sensing the driving environment in a way that feels natural to the driver. In recent years, moreover, the study of such control systems has come to include the economy of fuel consumption in addition to safe driving support as concern about the global environment grows.

Fig. 2—Evolution of the Driving Safety Support System. Advances in various types of technology are expected to bring improvements in function and performance and evolution toward automatic driving.

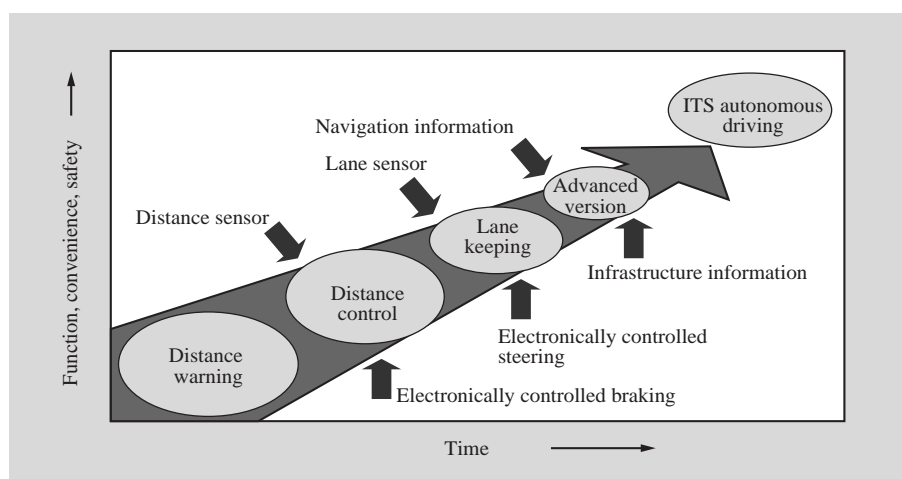

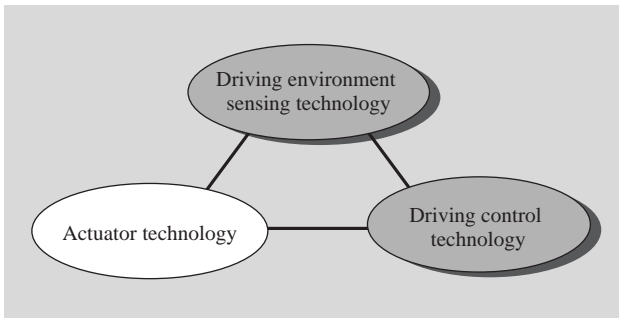

Fig. 3—Elemental Supporting Technology for Driving Safety Support System.

It is necessary to coordinate driving environment sensing technology, driving control technology and actuator technology.

Actuator technology relates to vehicle running, turning and stopping. Concerning the running function, progress is being made toward fully electronic control. Concerning the turning and stopping functions, progress is at the stage of steady evolution from the conventional hydraulic systems to electronic control.

The Efforts of Hitachi, Ltd.

As explained in the previous section, driving safety support systems require various technological elements.

Hitachi, Ltd. is taking on the challenge of developing a driving safety support system by both integrating various fields of technology within the

company and joint development with various manufacturers.

For example, we are incorporating safety control technology that has been applied in the Shinkansen train systems to automobile engine and transmission control technology to develop an even safer driving control system.

We are also in the course of linking our proprietary ultra-high-frequency semiconductor technology with the radar signal processing technology of Eaton VORAD Technologies, LLC in the US to develop a new millimeter-wave radar.

Other development projects include a compact in-vehicle image processing camera that combines image processing and recognition technology, which has already undergone a long period of development for industrial applications, traffic measurement, etc., with new semiconductor technology.

VEHICLE DRIVING CONTROL SYSTEM

Driving Control Technology

One objective of vehicle driving control system is to control the engine, automatic transmission and brakes so as to maintain safe headway distance according to the driving environment in front of the vehicle. Another objective is to improve fuel economy for protection of the environment. To meet these two objectives, Hitachi, Ltd. has developed an adaptive cruise control (ACC) system that controls engine and

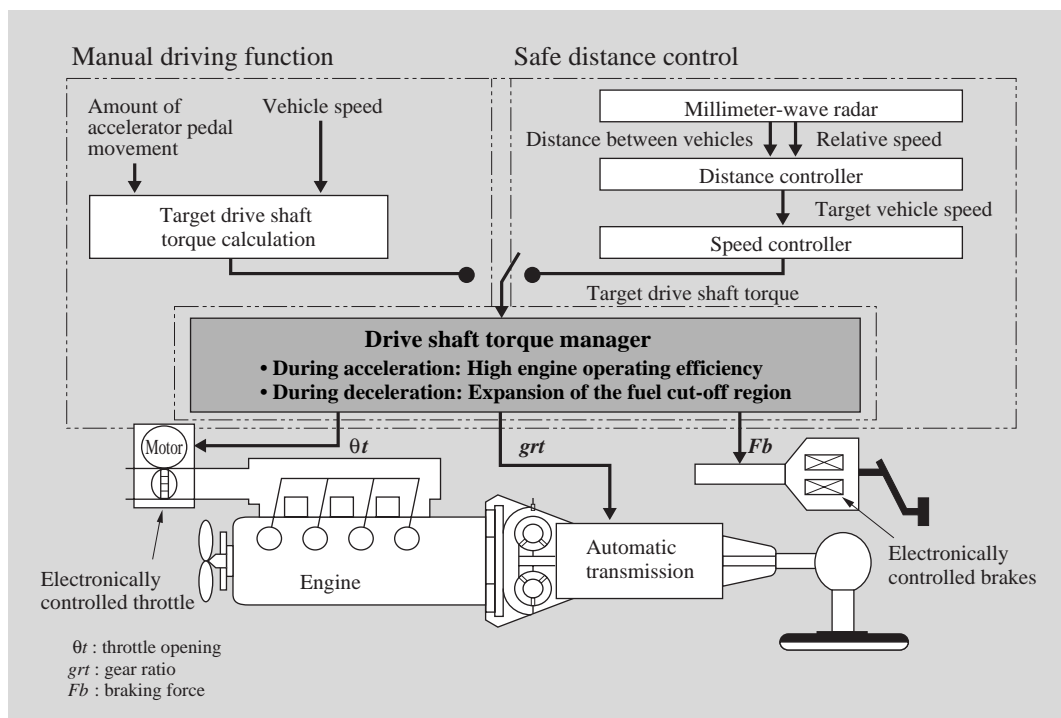
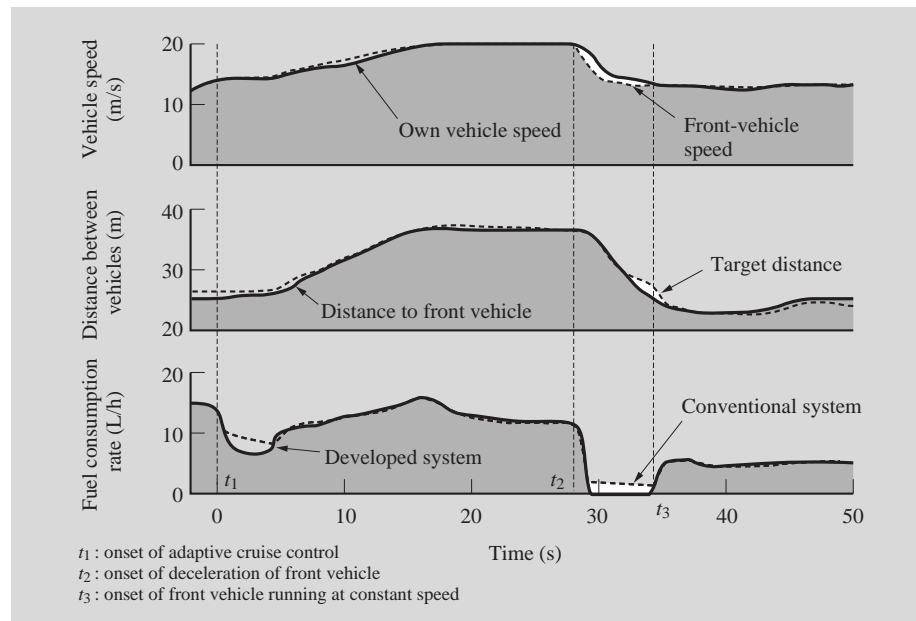

Fig. 4—Integrated Engine and Transmission Control Adaptive Cruise Control System. A control block configuration that facilitates switching between manual driving and adaptive cruise control is used.

Fig. 5— System Following Performance and Fuel Consumption Performance.
An evaluation confirmed improved fuel consumption of about 3.2% compared to Hitachi's conventional system.



automatic transmission in a coordinated fashion.

This adaptive cruise control system is outlined in Fig. 4.

In manual driving, the target drive shaft torque is calculated from the accelerator pedal angle and the vehicle speed. The drive shaft torque manager then determines the target throttle opening (θ_t) and target gear ratio (grt) from the target drive shaft torque. Fuel economy can be improved by driving the engine as efficiently as possible during acceleration and by expanding the fuel cut-off region using engine braking control during deceleration. This system can incorporate a cruise control function without changing the drive shaft torque manager because the speed controller can calculate the target drive shaft torque. The distance controller, moreover, can calculate the target speed and input it to the speed controller when incorporating the adaptive cruise control function. Also, when adding electronically controlled braking, a braking control algorithm based on the negative target drive shaft torque can simply be added to the engine and automatic transmission control algorithm of the drive shaft torque manager.

As described above, this system can have a modular structure that allows easy evolution from manual driving system to cruise control system and adaptive cruise control system¹⁾. The engine output torque and the gear change timing can be selected freely while the target drive shaft torque is being reached, so both accurate adaptive cruise control and improved fuel economy can be achieved.

Driving Test Results and Discussion

To study the performance and effectiveness of the adaptive cruise control system, we conducted driving tests. The results for headway control performance²⁾ and fuel consumption performance are shown in Fig. 5.

In this test, the deviation of the tolerance in the distance between vehicles was set to ± 1.5 m. The result was that the headway control performance was good for all running conditions, including acceleration, deceleration and constant speed running; the deviation between the target headway and the actual distance was confined to within about ± 1.5 m, thus verifying that this is a safe adaptive cruise control system.

Next, we compared the developed system and the conventional system for fuel consumption. With the developed system, in the initial vehicle speed pattern (after t_1), up-shifting was performed early by gear change timing control for fuel economy and so achieved lower fuel consumption than the conventional system. Furthermore, during the deceleration after time t_2 , this system executed engine braking control to down-shift from fourth gear to third gear and cut off the fuel supply, achieving zero fuel consumption. The conventional system, in contrast to that, does not downshift during deceleration and continues to consume fuel at a rate of about 2 L/h. The result is that for the particular vehicle speed pattern shown in Fig. 5, the newly developed system reduced fuel consumption by about 3.2%.



Fig. 6—Appearance of the Developed Millimeter-Wave Radar. The radar unit is more compact than the conventional product and is easily mounted on an automobile.

DRIVING ENVIRONMENT RECOGNITION SENSOR TECHNOLOGY

One important element for realizing vehicle-driving control is driving-environment sensors for recognizing vehicles and obstacles around the host vehicle.

There are various kinds of driving environment recognition sensors, which utilize different media, such as light, radio or ultrasonic waves. Hitachi, Ltd. has taken up the challenge of developing millimeter-wave radar, which is capable of accurate measurement in bad weather conditions, and an image-processing camera, which can detect various objects in the same way as the human eye.

Millimeter-wave Radar

Millimeter-wave radar is a sensor that can measure the distance to an object and the speed and azimuth angle of the object by transmitting a millimeter-wave signal and receiving the reflected signal from object. Currently, the radio frequency band from 76 to 77 GHz is allocated for automobile use in Japan, the US and Europe.

Hitachi, Ltd. has developed a one-body millimeter-wave radar unit mounted on the front of an automobile that can simultaneously measure the distance, the relative speed and the azimuth angle of vehicles in front³⁾. The external appearance of this radar unit is shown in Fig. 6 and its block diagram is shown in Fig. 7.

This millimeter-wave radar unit employs a newly developed millimeter-wave band integrated circuit (MMIC: microwave monolithic integrated circuit) for the high-frequency module that transmits and receives 76-GHz band radio waves. The MMIC chip set consists of four chips: a voltage-controlled oscillator, a power

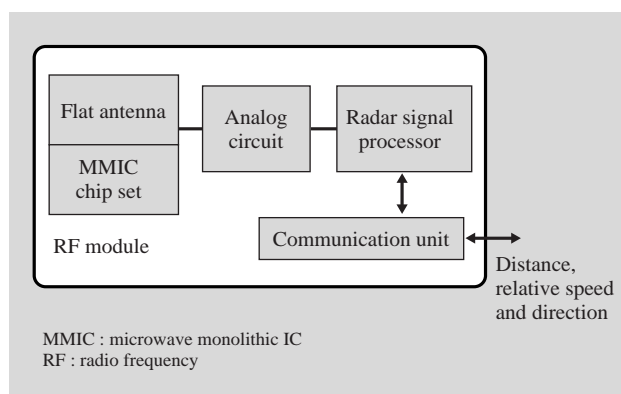

Fig. 7—Circuit Block Diagram of the Millimeter-wave Radar. Using MMICs and flat antenna makes a compact unit possible and a single-body millimeter-wave radar was realized.

amplifier, and two receivers. These chips are integrated in a monolithic RF (radio frequency) module combined with an integrated flat antenna. By integrating the RF module and signal processing board in the same housing, we were able to achieve a small, lightweight radar unit (for more information on the MMIC, see “Semiconductor Products for ITS applications” in this special issue).

The specifications of the newly developed millimeter-wave radar are listed in Table 1.

This radar unit employs two-frequency CW (continuous wave) radar modulation, in which a frequency-modulated signal is transmitted and the relative speed of objects is measured from the Doppler frequency and the distance to the objects is measured from the phase of the reflected signals. For azimuth angle

TABLE 1. Main Specifications of the Millimeter-wave Radar Specifications suited for the driving safety support system.

Item	Specification
Frequency	76.5 GHz
Modulation	Two-frequency CW (FSK)
Azimuth angle detection	Monopulse
Field of view	16°
Relative speed detection range	± 160 km/h
Relative speed detection resolution	0.1 km/h
Maximum detection distance	120 m
Minimum detection distance	Less than 1 m
Power consumption	Less than 6 W
Unit size	75 × 103 × 59 (mm)
Weight	0.5 kg

CW : continuous wave
FSK : frequency shift keying

measurement, the monopulse technique is used, in which the signals reflected from the vehicle are received by two antennas and the direction of the vehicle is determined from the amplitude ratio of those two received signals in a manner similar to stereovision. By applying these methods, continuous detection of the vehicle distances ranging from near to far can be achieved with a simple-structured device that involves no mechanical moving parts, providing a radar unit with excellent reliability for use in a driving safety support system.

The special features of this millimeter-wave radar device are listed below.

- (1) The unit is compact, lightweight and easy to mount.
- (2) Distance can be measured over a range from near to far.
- (3) There are no mechanical moving parts and angle detection is robust against vibration.
- (4) The accurate measurement of relative speed (0.1 km/h) allows precise vehicle control in response to fluctuations in vehicle speed.

In-vehicle Camera with Image Processing

Hardware configuration

We have made a prototype camera with image processing that can be mounted on a vehicle ⁴⁾. Photographs of this camera and the image processor are shown in Fig. 8.

In this camera, (1) FROM (flash read-only memory) chip that contains an image recognition program, (2) a 32-bit SuperH RISC (reduced instruction set computer) microprocessor (SH-3) for executing that program, (3) a high-speed RAM (random access memory), and (4) a newly developed application specific image processing LSI (video chip) are connected via the bus of the SuperH microprocessor. The special features of this camera are listed below.

- (1) Compact size is achieved by placing all image processing on a single board.
- (2) High-speed image processing (60 MHz per pixel) is achieved by using the dedicated image-processing chip.
- (3) High-speed recognition processing is achieved by using a high-performance microprocessor [120 MIPS (million instructions per second)].

Application to driving environment sensing

Recognition algorithms of the lane and the vehicle in front are described here. It is assumed that this information is to be used by the ACC system.

(1) Lane recognition algorithm⁴⁾

This function detects lane departure caused by driver carelessness or drowsiness while driving. First, a model of the two white lane marks on the road is created for the input image. This model is then used as the basis for recognizing lane type and lane changes. In addition, by adjusting the model shape to the actual white lane mark in the image, the shape and radius of curves in the road can be calculated from the changes in the model shape [(see Fig. 9 (a)).

(2) Forward vehicle recognition algorithm ⁵⁾

Because, millimeter-wave radar and laser radar have to measure distance to an object with limited power, it is difficult to obtain a wide field of view. For that reason, if a vehicle that is in the radar blind spot suddenly cuts in front the subject vehicle, delayed deceleration or emergency braking will occur, giving the driver an unsafe or uncomfortable feeling. To solve that problem, a camera with a wide-angle lens is used to recognize vehicles that are running nearby the subject vehicle. First, vehicles that are passing in the neighboring lanes are recognized from the input image. Then, vehicle tracking based on the features of the passing vehicle is performed and the position and relative speed of the passing vehicle are measured. In addition, if the vehicle that is being tracked crosses over into the lane in which this vehicle is driving, an alarm warns the driver and a deceleration request is sent to the ACC system [see Fig. 9 (b)].

Because this image-processing camera is configured with a high-performance RISC micropro-

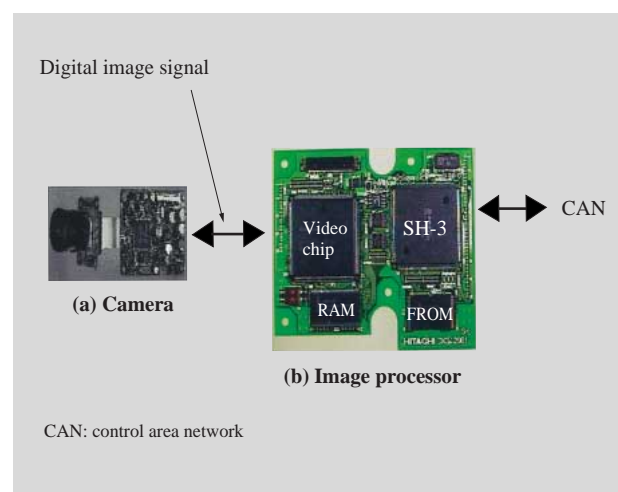

Fig. 8—External Appearance of the Image Processing Camera and Image Processor.

The compact size of 90 mm by 70 mm was achieved by using a newly developed application-specific image processing LSI chip (video chip).

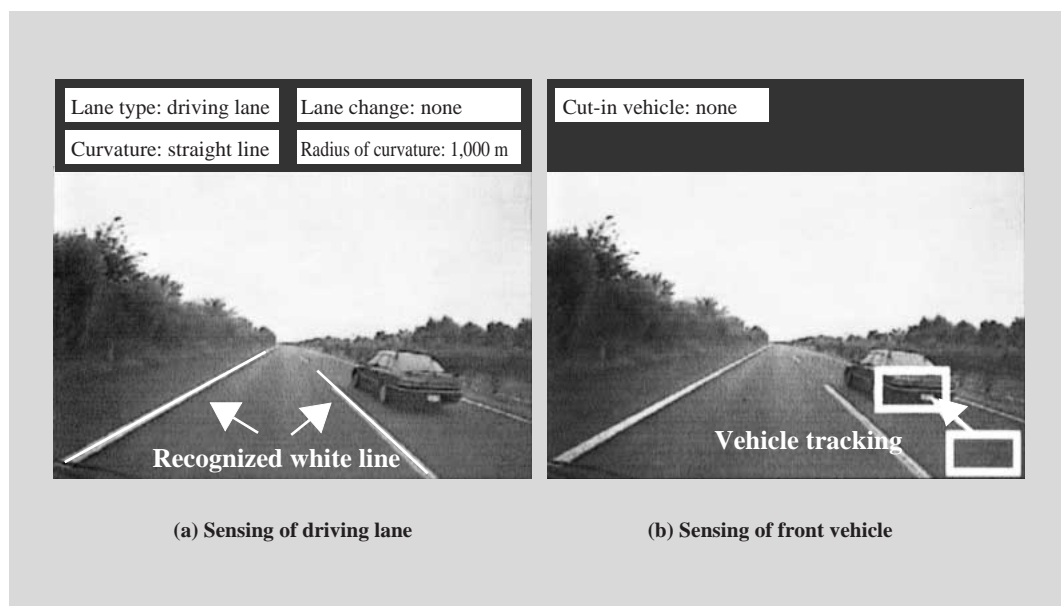

Fig. 9—Example of Driving Environment Sensing by Image Processing Camera. The image processing chip is capable of high-speed sensing processing.

cessor, it will be possible to achieve more advanced recognition functionality and higher performance as microprocessor performance advances. In future, sensor fusion with millimeter-wave radar and other such improvement should become possible.

PROBLEMS AND FUTURE EVOLUTION OF THE DRIVING SAFETY SUPPORT SYSTEM

Current driving safety support (ACC) systems are assumed to be used on limited access highways. The reason for that assumption is that the range of recognition technology in the existing driving environment is limited.

In future, to expand the user base, it is necessary to realize a system that is capable of increasing driving safety and reducing the burden on the driver on ordinary roads as well.

The first step toward that goal is improvement of the driving environment recognition technology. From now into the future, new devices and technology will appear and the technological level will gradually increase, but we believe it will take some time until human senses and judgment can be completely replaced.

For the solution to these problems, there is great expectation for the establishment of ITS and other such infrastructure.

Along with expectations that advanced driving support systems and automated driving can be achieved by adding intelligence to automobiles and road systems, the difficulty of dealing with the road side of

the system becomes an issue of concern. The deployment of such an infrastructure on all roads in Japan is clearly difficult to even imagine. How to combine automobiles and the infrastructure while making infrastructure investment feasible is a matter for thought when considering automated driving in the ITS.

In other words, systems that depend on the infrastructure must consider the cost-effectiveness of shared investment, while systems that place emphasis on autonomous running of the vehicle are limited in the amount of driving environment information they can obtain. It is therefore important to create a system that achieves a good balance between these two opposing approaches.

While not addressed here, human-machine interface technology that can provide a harmonizing effect between the driver and the system is also indispensable to the driving safety support system. That is because machines will perform tasks that the driver had performed previously, and a mechanism is needed that allows the driver and vehicle to cooperate in a natural way without making the driver uneasy. It is expected that the car information system, which includes the navigation system, will play an important role in this mechanism.

CONCLUSIONS

We have described the trend in automobile driving safety support system development, the development situation in Hitachi, Ltd., and the problems and future

evolution concerning the driving safety support systems.

The driving safety support systems are expected to contribute to a reduction in traffic accidents and are considered to be increasingly necessary in the future of our aging society.

A key to achieving such a system is driving environment recognition technology. Hitachi, Ltd. will contribute to the realization of safety-related systems, keeping preparation of the future infrastructure and human-machine interface technology in view.

REFERENCES

(1) T. Minowa et al., "Powertrain Control System Based on Wheel

Torque for Future Safer Vehicle," ISATA Paper, 98AE023 (1998.6).

(2) S. Kuragaki et al., "An Adaptive Cruise Control Using Wheel Torque Management Technique," SAE Transactions, 98060 (1998.2).

(3) H. Kuroda et al., "An Adaptive Cruise Control System Using a Millimeter Wave Radar," IEEE International Conference on Intelligent Vehicles (1998.10).

(4) Takenaga et al., "Development of a Compact Image Processing Device and Application to Driving Environment Recognition," 1999 Fall Conference of the Japan Society of Automotive Engineers, No.78-79, 13-16 (1999).

(5) H. Morizane et al., "Cut-in Vehicle Recognition System," IEEE/IEEJ/JSAI International Conference on ITS, 976-980 (1999).

ABOUT THE AUTHORS



Jiro Takezaki

Joined Hitachi, Ltd. in 1978 and now works at the Automotive New Technology Developing Center of the Automotive Products. He is currently engaged in the development of sensors for driving control systems. Mr. Takezaki is a member of the Japan Society of Automotive Engineers, and can be reached by e-mail at takezaki@cm.jiji.hitachi.co.jp.



Nobuyuki Ueki

Joined Hitachi, Ltd. in 1999 and now works at the Automotive New Technology Developing Center of the Automotive Products. He is currently engaged in the development of vehicle driving control systems. Mr. Ueki is a member of the Japan Society of Automotive Engineers, and can be reached by e-mail at n-ueki@cm.jiji.hitachi.co.jp.



Toshimichi Minowa

Joined Hitachi, Ltd. in 1986 and now works at the Vehicle Control Group of the Third Department of Systems Research of Hitachi Research Laboratory. He is currently engaged in the development of automobile operation support systems and transmission control systems. Mr. Minowa is a member of the Japan Society of Mechanical Engineers, the Japan Society of Automotive Engineers, and the Society of Automotive Engineers. E-mail: tminowa@hrl.hitachi.co.jp.



Hiroshi Kondoh

Joined Hitachi, Ltd. in 1994 and now works on a millimeter-wave development project in the Communication Systems Laboratory of the Central Research Laboratory. He is currently engaged in the development of millimeter-wave automobile radar, MMICs and transceiver modules for ITS wireless communication. Dr. Kondoh is a member of IEEE and the Institute of Electronics, Information and Communication Engineers, and can be reached by e-mail at h-kondoh@crl.hitachi.co.jp.