

Information Systems

Electronics

Power Systems

Industrial Systems

Healthcare Systems/Biotechnology

Consumer Products

Research & Development

**Research & Development**

**Research &  
Development**

# New Semiconductor Spintronic Effect

A new spintronic effect has been discovered in semiconductor chips: the Intrinsic Spin-Hall Effect. This phenomenon, observed by optical measurements in a unique experimental system, adds a new spin to the possibility of circuits with low energy consumption.

The international team is composed of physicists Dr. Jörg Wunderlich and Dr. Bernd Kaestner from Hitachi Cambridge Laboratory, U.K., Prof. Tomáš Jungwirth from the Institute of Physics of the Academy of Sciences of the Czech Republic and the University of Nottingham, U.K., and Prof. Jairo Sinova from Texas A&M University, U.S.A.

The Hall effects are among the most recognized phenomena in basic physics and applied microelectronics. They have shaped our fundamental understanding of metals and semiconductors, and are utilized in numerous devices for sensing and internal magnetization in conductors, or as the electrical resistance standard. In the “classical” Hall Effect, a magnetic field deflects moving charges, electrons, for example, towards one edge of the sample creating a voltage transverse to the current. This is used to measure magnetic fields. However, electrons carry not only the electric charge but also a tiny magnet called spin. These spins can also be deflected towards one or the other edge, depending on their orientation,

without applying a magnetic field. In a ferromagnet like iron, nearly all electrons have the same spin orientation and, hence, are deflected mostly to one edge of the conductor, creating a voltage transverse to the current. This so-called Anomalous Hall Effect occurs even without the application of a magnetic field.

The Spin Hall Effect is similar to the Anomalous Hall Effect in that it is again the opposite spins that are deflected towards opposite edges when an electrical voltage is applied along the conducting layer. In this case, however, the layer is made of a normal semiconductor whose electrons do not prefer a specific orientation of their spins. Therefore no charge imbalance builds up but the edges become magnetized.

Our observation of the Spin Hall Effect at Hitachi Cambridge Laboratory was made in a specially designed ultra-thin layer embedded within a semiconductor chip together with built-in light emitting diodes for detecting the signal.

This possibility of inducing and controlling magnetization in semiconductors by electrical voltage is unprecedented. The discovery puts a new twist on the research to date and expands the horizon of spintronics technologies, which a few years ago revolutionized the computer memory industry and which so far have utilized naturally magnetized metals.

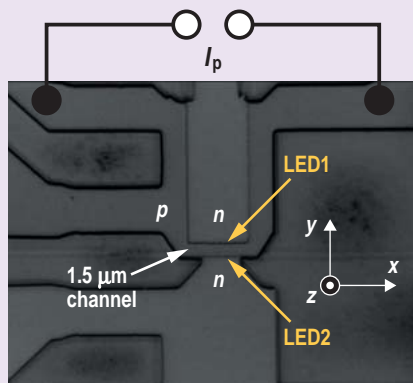

Scanning electron microscope image of the SHE LED device

SHE: Spin Hall Effect  
LED: light emitting diode

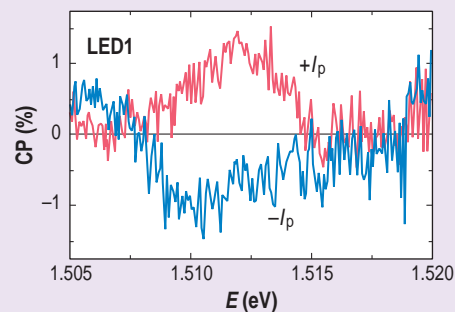

(a) Polarization along z axis measured with active LED1 for two opposite  $I_p$  directions

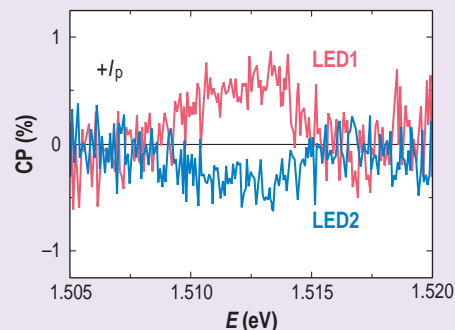

(b) Polarization along z axis measured with fixed  $I_p$  current and for biased LED1 or LED2

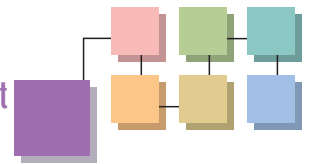

## RFID Sensor Chip for DNA Analysis

Hitachi has developed a  $2.5 \times 2.5$  mm RFID sensor chip capable of detecting and transmitting the data collected on SNPs (single nucleotide polymorphisms) in DNA (deoxyribonucleic acid). As the chip can operate in solution, it can be used to detect and transmit SNP data from within a sealed container holding a DNA sample solution, using passive RF communication, to an external wireless reader unit located outside the solution. Further, anticollision control was developed to enable data collection from multiple chips in the same solution at the same time. This technology is expected to provide a simple and convenient SNP typ-

ing method for healthcare tailored to treat individual genetic predispositions (personalized medicine) in local clinics and hospitals. This work was performed as a part of a research and development project of the Industrial Science and Technology Program supported by the New Energy and Industrial Technology Development Organization (NEDO) in Japan.

Prototype antenna-embedded DNA sensor chip (left) and architecture of RFID sensor system (right)

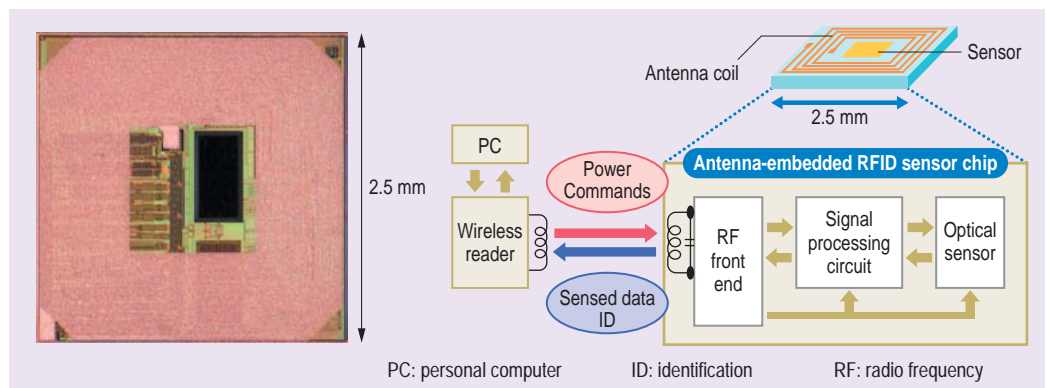

## World's Smallest Size Sensor Node for Sensor-net System

Sensor-net is a next-generation information system based on sensing data which flows in continuously from the smallest wireless and battery powered sensor nodes. Potential blind areas and distant danger become "visible" using sensor-net, and a more efficient and safer management system can be achieved. In this sensor-net system, small size wireless sensor devices, which are called sensor nodes, play an important role as feelers of the sensor-net system. Hitachi, Ltd. and YRP Ubiquitous Networking Laboratory developed the world's smallest ( $6.9 \text{ cm}^3$ ) battery life sensor node that can

operate for over one year, which contains a microprocessor, RF transceiver, temperature sensor and sensor interfaces, and a Li-ion battery. The small size is necessary for sensor nodes to embed themselves into things in the external environment, equipment, and people's possessions. Small size is achieved using chip size packaging technology, but the small size of the battery reduces the battery life. In balancing compact size and long battery life, low power consumption technologies, which are the periodic transmit-receive operation, power-conscious multiple-access method, and power switching mechanism, have been developed. Based on these technologies, the sensor node has a battery life of approximately 18 months. Also the sensor node is capable of interfacing with other kinds of sensors, such as temperature, humidity, light, infrared, and acceleration.

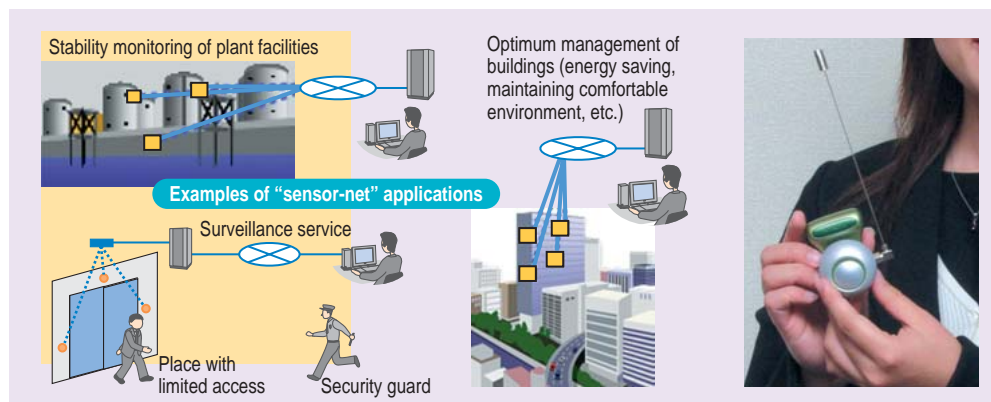

Sensor-net system which is widely spread over the real world

## Finger Vein Personal Identification Technology Using Sunlight

Hitachi has developed advanced technology for personal identification using finger vein patterns. Vein patterns can be observed by transmitting near infrared light through the finger and the uniqueness of the vein pattern can be used to identify a person. The developed technology allows for the use of natural sunlight as a light source for capturing the vein pattern as well as the conventionally used exclusive infra-red light source. As the brightness of sunlight is influenced by the weather and the surrounding environment, this technology adaptively controls both the sensitivity of the image sensor and the brightness of the back-up light source in response to the measurement conditions to provide the best quality vein pattern image. Accordingly, the new system can be used in both very dark places, e.g. indoors at night, and very bright places, e.g. outdoors on sunny days, and is suited to exterior security applications such as access to motor vehicles and home entrances.



Personal identification using sunlight

## First Realization of 16-level Modulation for Ultra-high Capacity Optical Fiber Communication

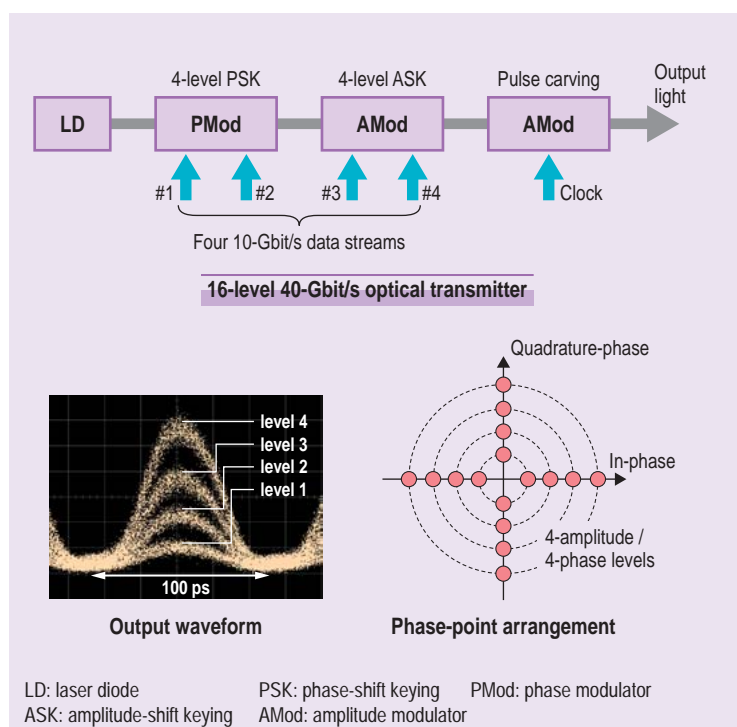

16-level 40-Gbit/s optical modulation

Hitachi has developed a 16-level multi-level optical modulation that is capable of carrying 4 bits per one symbol. The “multi-level modulation” is a key technology for achieving ultimate efficiency in the world of electrical communication. Multi-level modulation is commonly used in advanced mobile radio communications and high-speed ADSLs (asymmetric digital subscriber lines). However in the high-speed optical fiber communication at 10 Gbit/s or beyond, it has been impossible to realize a signal modulation with more than eight levels, because of the difficulty of the signal modulation/demodulation at such a high speed. The proposed technology is the “amplitude and phase co-modulation technology,” locating the signal phase points on a co-centric circles, which greatly simplifies the configuration of the modulation and demodulation circuits suitable for high-speed use. Applying this new technology to 10-Gbit/s transmission, Hitachi achieved a quadruple increase in the transmission capacity, that is, 40-Gbit/s transmission with the combination of 4-level amplitude modulation and 4-level phase modulation. This technology will open up a way for further growth of the ultra-large capacity optical-fiber communication, supporting the ever-growing Internet and future content-rich broadband services.



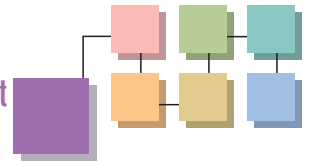

## Next-generation Management Technologies for Large-scale Computer Systems

Today's data centers are suffering from over-provisioning, that is, they have to maintain extra servers in order to handle peak traffic loads. There are large-scale computer systems where many applications are running on dedicated servers without resource sharing. This situation results in decreased resource utilization, increased management complexity and higher management costs. Hitachi has previously developed server management technologies including mid/long-term predictions and server re-allocation to solve the above problems. When the management system detects a load surge in Service A, it will select the over-resourced service between Service B and C. Using mid/long-term prediction technology, it anticipates the future load behaviors of Service B and C after server re-allocation is performed based on the load history of each service. Then, it suggests the number of servers which can be removed from each service while maintaining their service levels. Using the server re-allocation technology, the servers in the selected Service C are removed and added to Service A without degrading the service quality of C and the management system can deal with the load surge observed in Service A. These technologies will be integrated into Hitachi's system management product.

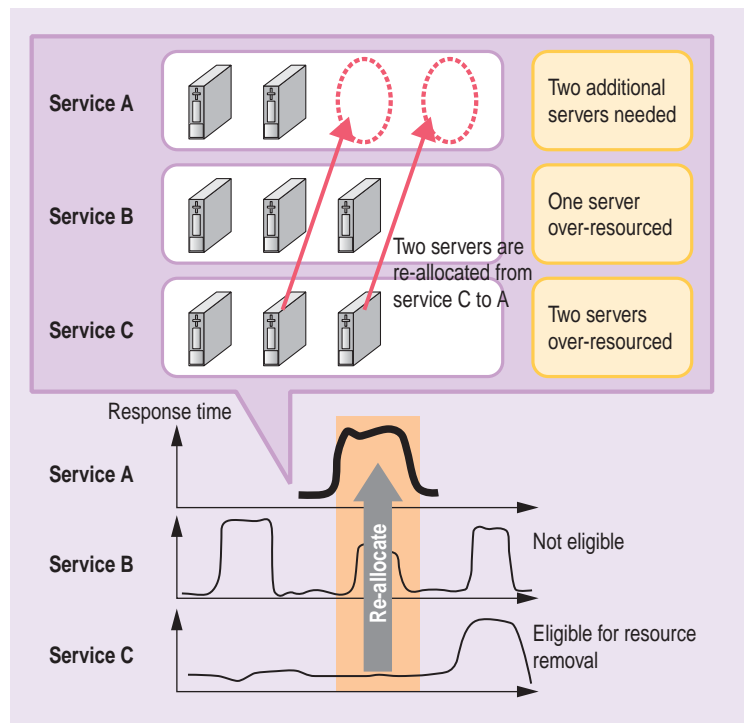

The load characteristic of each service is predicted based on the load history.

## Ground-breaking All-around Three-dimensional Display System



All-around three-dimensional display system

Hitachi Human Interaction Laboratory has developed an all-around three-dimensional display system that enables projected images to be viewed from any angle. This is made possible by projecting 24 images of an object, taken from 24 angles, onto a spinning screen. Without using glasses designed for three-dimensional image viewing, audiences will perceive projected images as real objects floating in space before them.

Using a special camera system in conjunction with the display system makes it possible to project images of real objects in real time. Furthermore, images captured by the camera system can be transmitted via a network. These features will provide designers and engineers in various fields with multiple application possibilities.

Currently, the most widely used method of displaying three-dimensional images is holography. Holography makes it possible to show three-dimensional images without the need for special viewing glasses, but the technology does not allow objects to be displayed in real time. With Hitachi's technology, three-dimensional images like those seen in science fiction and action movies will be available for audiences to enjoy.

## High-resolution Full-color Liquid Crystal Display Driven by Organic Thin-film Transistors

Hitachi, Ltd., the National Institute of Advanced Industrial Science and Technology, and the OITDA (Optoelectronic Industry and Technology Development Association) have successfully fabricated a full-color LCD of a 1.4-inch diagonal size driven by organic TFTs (thin-film transistors). This LCD has  $80 \times 80$  pixel arrays addressed by organic TFTs with a channel width of  $50 \mu\text{m}$ . A solution-processed passivation film has been newly developed to protect the TFTs against degradation induced by integration with an LCD device. In addition, the contact resistance between the organ-

ic semiconducting film and the metal electrodes has been reduced by steepening the edge slope of the electrodes. Consequently, the organic TFT-LCD is capable of displaying full-color moving images for the first time at a resolution of 80 pixels per inch, the highest reported resolution. Organic TFTs can be fabricated using a printing process and have the potential of meeting the requirement for the future low-cost switching devices to drive flexible sheet displays such as electronic papers or posters.

A part of this work belongs to the "Advanced Organic Device Project" under contract between OITDA and NEDO (The New Energy and Industrial Technology Development Organization).

[Main specifications]

Panel size: 1.4 inches diagonal

Resolution: 80 pixels per inch

Pixel number:  $80 \times 80$

Pixel size:  $318 \mu\text{m} \times 106 \mu\text{m}$

TFT size:  $50 \mu\text{m} \times 5 \mu\text{m}$

Frame frequency: 60 Hz

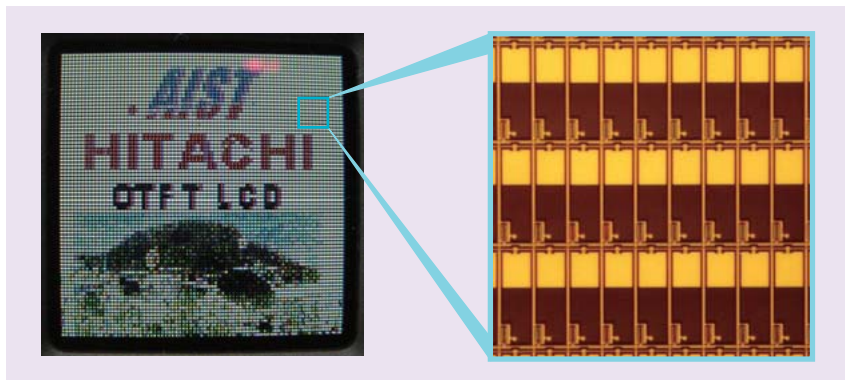

Organic-TFT driven color LCD and pixel structure

## Human-symbiotic Robot



Human-symbiotic robot

Hitachi is developing robots capable of playing support roles to people, i.e. human-symbiotic robots. These kinds of robots must have the following features, that is, they must be able to coexist with people, be user friendly and capable of supporting people. As a step to the final goal, Hitachi developed an autonomous mobile robot featuring the following:

- (1) Collision avoidance capability for moving safely through complex environments, developed from the joint research of Tsukuba University and Hitachi, Ltd.
- (2) Self-balancing two-wheel mobile system as well as a body side swing mechanism to shift the center of gravity. This allows the robot to move nimbly, at a clip of six kilometers per hour.
- (3) Ability to interact with people naturally without special tools by means of distant-talking speech recognition technology and high quality speech synthesis technology.

This robot is a major step toward the day when intelligent robots will live and work alongside humans. It appeared in The 2005 World Exposition, Aichi, Japan, entrusted by NEDO (The New Energy and Industrial Technology Development Organization).

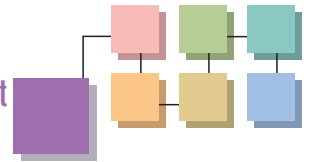

## Micro Mixing Server Using Micromixer for Production

Hitachi developed a micro mixing server using a micromixer with a high flow rate for production. This system can instantaneously mix up to six kinds of liquids at ratios chosen by the user. The micromixer is capable of processing tens of milliliters of liquid per minute and has a wide range of applications from the development

of chemical agents to the production of lotions and cocktails. As shown in Fig., in order to mix up to six kinds of liquids at arbitrary ratios, multilayer flows made by streamline nozzles, which are arranged in the shape of a matrix (100 × 5), are formed. A uniform high-speed mixture can be achieved with the molecular diffusion between the multilayer flows of 1,001 sequences formed in a sheet-like channel. As shown in Fig. (b), the liquids discharged from the first nozzle array flow between the liquids discharged from the slit-like nozzle. Similarly, the liquids discharged from the second nozzle array flow between the liquids discharged from the first nozzle array. Repeating to the fifth nozzle array creates a multilayer flow of 1,001 sequences.

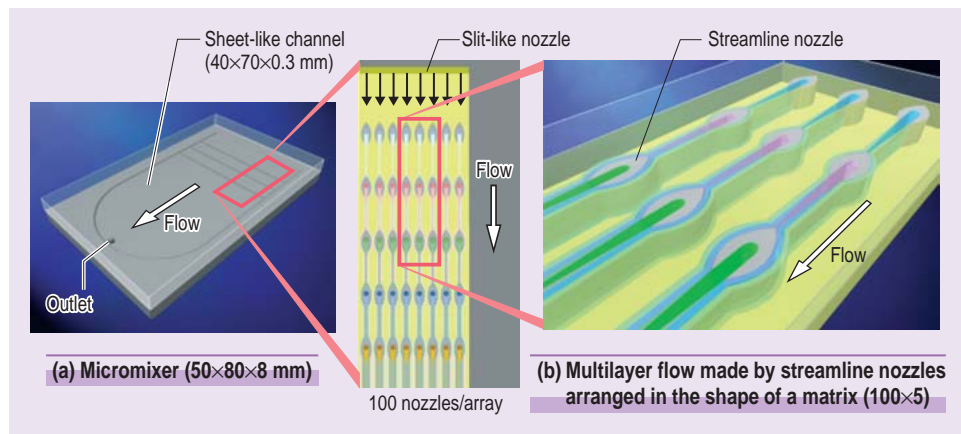

## Simulation of Physical Properties at Interfaces between Nanometer-thick Films

A molecular-dynamics technology for accurately simulating the physical properties of interfaces between nanometer-order-thick films made of different materials that are used for semiconductor and storage devices has been developed. This technology significantly reduces the calculation time by replacing electronic-state change at the interfaces with the change of force on atoms. This technique enables Hitachi to deal with systems containing tens of millions of atoms, as well as simulating the formation of atom combinations. The technique also enables delamination at the interfaces during heat treatment

in the manufacturing process. Hitachi can also predict the diffusion coefficient and adhesion strength, which are very difficult to calculate with conventional simulation methods. This work will help to reduce the development time of the next-generation advanced devices, and accelerate the development of high-performance devices.

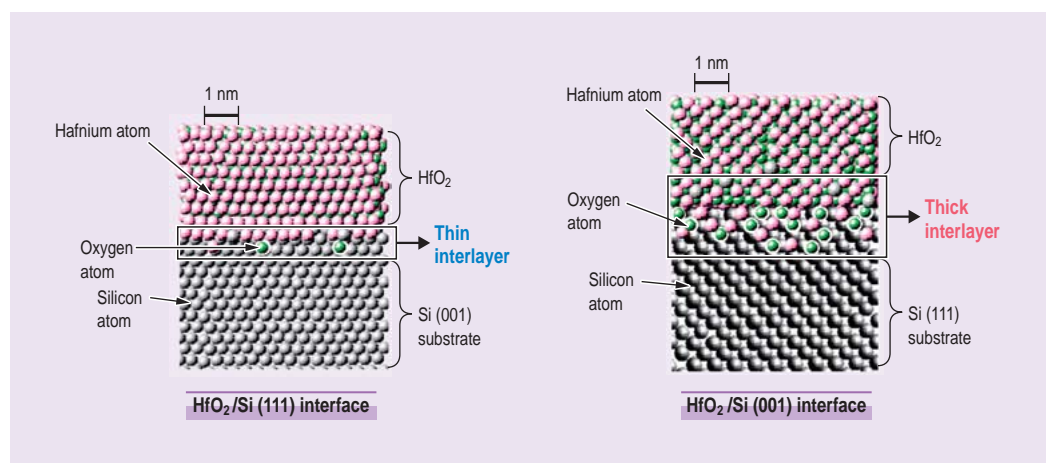

Examples of simulation of interfacial-layer formation

# Disc Vibration Control Structure for High-speed-recording Optical Disc Drives

Hitachi developed a DVC (disc vibration control) structure that enables a stable read-write performance for 16X-DVD drives by controlling the airflow around the disc. High capacity optical disc drives require high-speed operations to read and write large amounts of data in a short time. The maximum disc rotation speed of 16X-DVD drives reaches 10,000 rpm, and the data transmission speed reaches 22 Mbyte/s. While discs are rotating at around 10,000 rpm, they are greatly influenced by airflow, and nodal diameter modes so dramatically that read/write errors are caused. Therefore, Hitachi developed a DVC structure for the drive top cover to control the vibrations.

The DVC structure controls:

- (1) The airflow used to reduce the disc vibration amplitude of (0,2), (0,3), (0,4) nodal diameter modes;
- (2) The node and loop positions of those vibration modes to reduce the relative inclination between the disc and the optical head;

This technology is currently being applied to the 16X-DVD mass-production models of Hitachi-LG Data Storage, Inc.

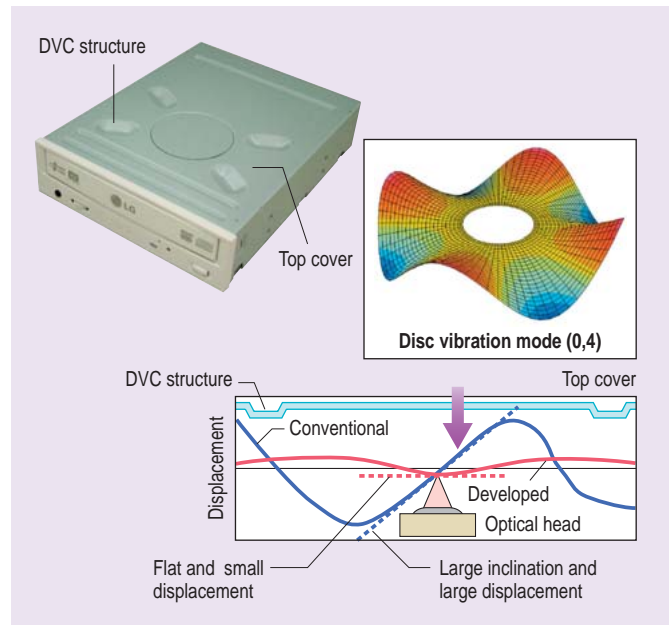

Super Multi DVD Drive (above left) and DVC technology (below right)

# Technology for Predicting Traffic Conditions

Analyzing enormous amounts of past traffic data and taking road connection conditions and features of variation in traffic conditions into consideration, technology for accurately predicting future traffic conditions has been developed.

The technology is adopted as the mobile information service for Edia Co., Ltd. It has been in service since March 2004. Hitachi, Ltd. and Xanavi Informatics Corporation jointly developed the navigation system to which the technology was applied. The navigation system was released in June 2004.

The prediction technology has been incorporated into traffic conditions displays and route searches. The users can get more accurate arrival times and faster route projections than can be provided by conventional systems.

In the years ahead, we will improve the prediction technology using not only existing traffic data but probe vehicle data and try to enhance the convenience of the traveler information service.

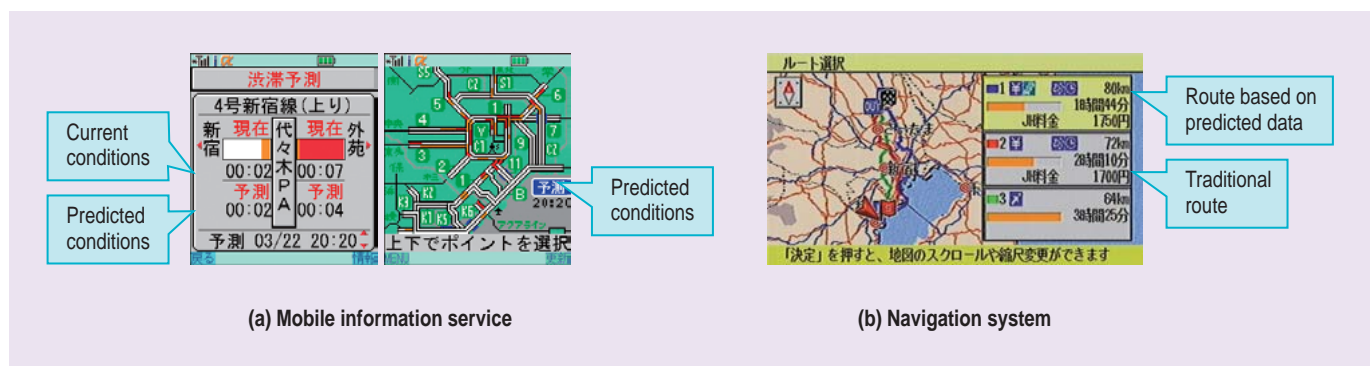

Samples of displays of predicted traffic conditions



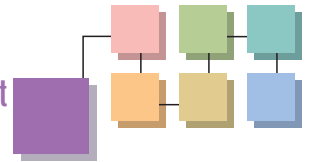

## Prototype of Direct Methanol Fuel Cell for Portable Equipment

A DMFC (direct methanol fuel cell) has been developed as a power supply for next-generation portable equipment (tens of watts from several watts) by Hitachi.

DMFC produces electricity from water, methanol, and oxygen. DMFC is a high-energy and high-density fuel cell that can take the place of lithium ion batteries. It is possible to use it continuously without requiring charging by exchanging fuel cartridges (jointly developed with Tokai Corporation). The exhaust generated by the cell is comprised of only water and carbon dioxide. The cell is environmentally friendly. DMFC is expected to be used as a new energy source that supports platforms enabling the ubiquitous exchange of information.

A part of this development was funded by the NEDO (New Energy and Industrial Technology Development Organization).



Prototype of methanol fuel cell drive multi-viewer

## EMC Evaluation Technique for Automotive Devices Using Coupled Circuit and Electromagnetic Simulation

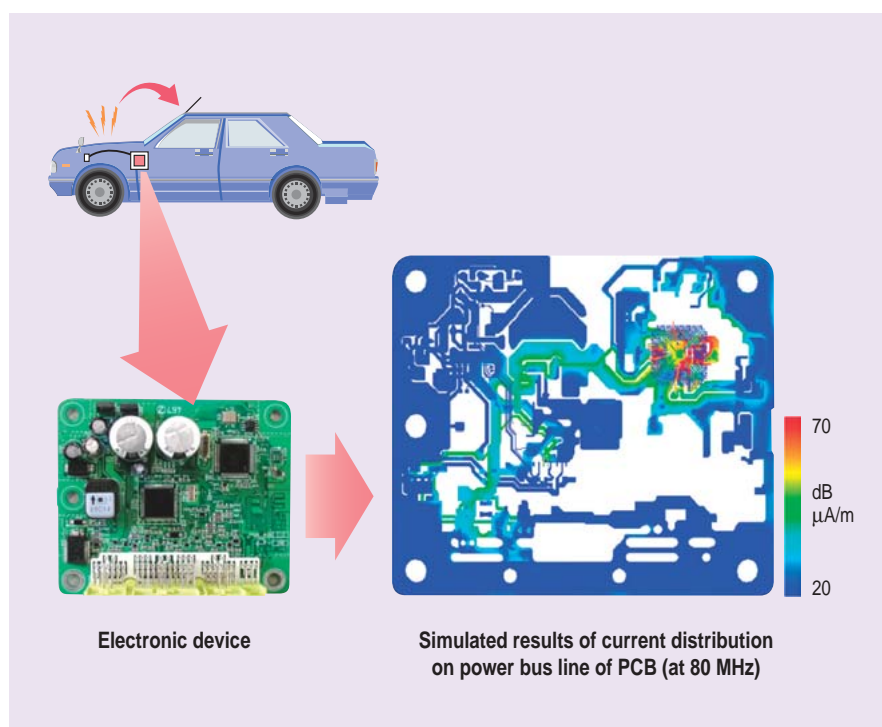

There is a “radio noise problem” in automobiles that causes noise in car radios. Radio noise is caused by the electromagnetic radiation emitted from the ECU (electronic control unit). Because there are many ECUs in a car, and high-speed LSIs are used in these devices, radio noise becomes a serious problem in automobiles. Consequently, an EMC (electromagnetic compatibility) evaluation technique for automotive devices using coupled circuit and electromagnetic simulation has been developed.

The developed simulation technique can evaluate a high-frequency current that flows on the PCB (printed circuit board) and is clearly the cause of radio noise. Furthermore, a complicated patterned PCB, a real ECU, for example, can be monitored with this simulator. We would like to develop interface software such as pre-processors and postprocessors and apply this software to developing an electronic device capable of functioning as a support tool.

EMC evaluation technique for automotive devices using coupled circuit and electromagnetic simulation

## Ultra-small Ubiquitous Controllers: UbiCompo

Hitachi has developed ultra-small ubiquitous controllers called "UbiCompo" designed for remote monitoring and plant control systems. UbiCompo can monitor and control systems via wireless networks and the World Wide Web.

One of the key features of UbiCompo is a component-based architecture. An embedded computer can be built up of a set of modules on the component-based architecture. We can integrate a specific purpose controller for each system by combining only the required modules. Users can select the appropriate communication network such as Ethernet, wireless LANs, and Bluetooth\* according to the place where the controller is set up. Input/output modules (serial, digital input/output, image input modules are available) are also selectable depending on the target of the remote monitoring system.

Hitachi has integrated a UbiCompo controller in a palm-top size by utilizing embedded hardware and software technology. These features enable users to place the controller wherever they want. A user can monitor the existing systems or machines more easily than using the proprietary controllers.

\* See "Trademarks" on page 86.

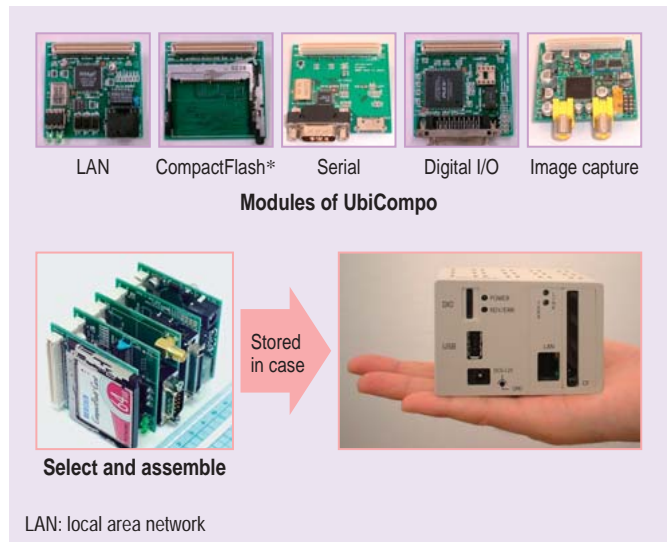

Modules and architecture of ultra-small ubiquitous controllers "UbiCompo"

## System Power Module with Sinusoidal Input/Output Currents for PM Motor Drives



System power module with sinusoidal input/output currents for PM motor drives

PM motors (permanent-magnet synchronous motors) are widely used in many drive applications since they enable a highly efficient system. However, an AC to DC converter and an inverter are required to drive the PM motors at varying speeds. These circuits are complicated and need high technological control algorithms. Hitachi developed a new power module ISPM (inverter system power module) suitable for PM motor drives.

[Advantages of ISPM]

- (1) Sinusoidal input current and unity power factor are achieved.
- (2) PM motor drive without sensors but with sinusoidal currents is enabled.
- (3) All circuits for PM motor drive including the microprocessor are packaged in one module.

Hitachi developed a new control technique for ISPM that does not need the sensors of power source, the rotor position sensors and the phase current sensors for PM motors. All of the controls are realized using only one microprocessor "SH7046."

Using this ISPM, a high efficiency and low harmonics motor drive system can be achieved only by connecting it to both an AC power supply and a PM motor. ISPM is currently used in packaged air conditioners. Hitachi is planning to apply ISPM to other products.

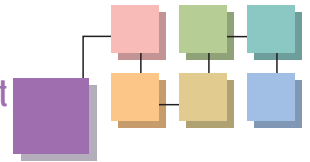

## Lightweight Protocol Stack for Embedded Microcomputer

The ubiquitous provision of information will be achieved as information technologies pervade the physical environment. A number of new service systems are driven by smart devices that provide context information in the surrounding environment of end-users. This trend requires lightweight communication software capable of interconnecting with small embedded devices of end-users that have limited resources. Hitachi has developed lightweight communication software that enables wireless web server communications via compact microcomputers. This technology enables less-memory implementation of protocol stack by optimizing communication software. High connectivity is also assured by implementing stan-

dard protocol stacks like TCP/IP, UDP/IP, and HTTP so that it is seamlessly connected to information systems. A prototype model has successfully been developed by using a wireless LAN (IEEE802.11b) or Bluetooth and a tiny microcomputer with 2 kbyte RAM / 32 kbyte ROM. Examples of applications are a communication adapter for equipment monitoring in industrial systems, sensor network platforms for home appliances or building equipment, and so on. Many other applications called ubiquitous information systems are expected to be developed using this technology.

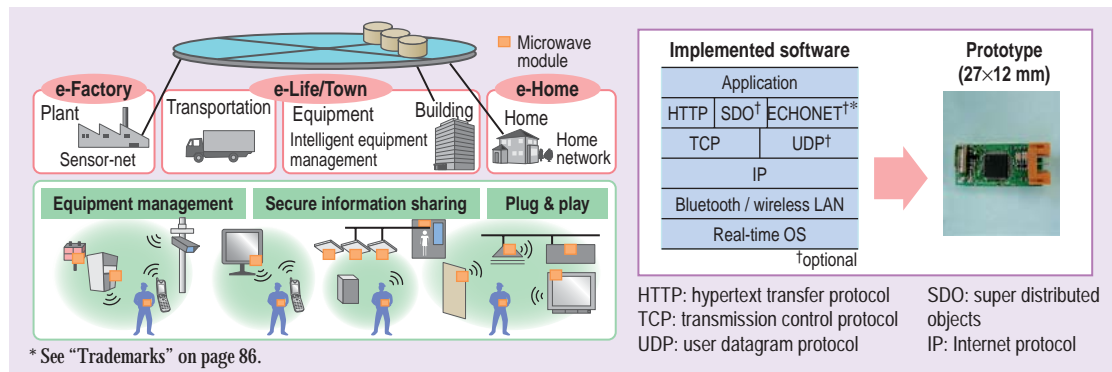

Lightweight protocol stack embedded in a microcomputer (right) and application image (left)

## Technology for Securely and Efficiently Implementing Public Key Cryptosystems on Lightweight Devices

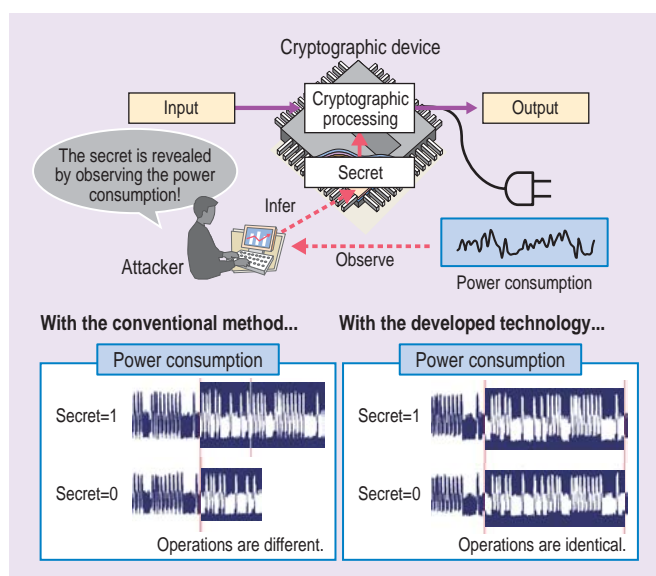

Side channel attack

When the provision of information becomes ubiquitous in the surrounding environment, lightweight devices such as smartcards and RFID tags will play crucial roles in the effectiveness of the systems. In such devices, public key cryptosystems are often used when verifying the authenticity of a counterpart. However, these devices exhibit vulnerabilities, namely side-channel attacks: The attacker observes physical information such as execution time, power consumption and electromagnetic radiation while the device performs cryptographic applications, and utilizes it for revealing confidential information contained inside the device.

As a countermeasure to this particular vulnerability, we developed a technology for securely implementing public key cryptosystems. Not only guaranteeing the implementation security, the technology is high speed and has a small memory requirement during cryptographic processing. Furthermore, the system can be optimally customized regarding the speed and memory depending on active applications on the device, which is preferable for cellular phones. In addition to conventional public key cryptosystems, the technology is also applicable to ID-based cryptosystems in which e-mail addresses can be directly used as a public key.



# 3D Fluidal Analysis Technique for Shortened Developmental Timeframe for Plastic Components

Hitachi has developed a high-precision technique capable of predicting the three-dimensional, fluidal behavior of resin in molding processes, focusing on the thermosetting compound used in sealing electronic components and the foaming polyurethane used in refrigerators and automobile interiors. Hitachi has developed equations, based on experiments, that describe the complex changes in physical properties that occur as the chemical reactions progress, and have constructed a system in which these equations are combined with the general-purpose thermal flow software, "FLOW-3D\*." This system permits advance identification of defects that arise in complex structures, and allows the rapid selec-

tion of optimal structures and processes independent of the prototype construction, thus contributing in no small way to reducing the developmental timeframe for various products in the company. As an extension of this effort, Hitachi has implemented a "NEPTAS" system that provides consistent analyses of residual strain and stress remaining after the solidification process in thermosetting compounds.

This technology will be made available to outside parties in the form of analysis services provided through the i-engineering website of Hitachi, Ltd. as well as through purchasable software.

\* See "Trademarks" on page 86.

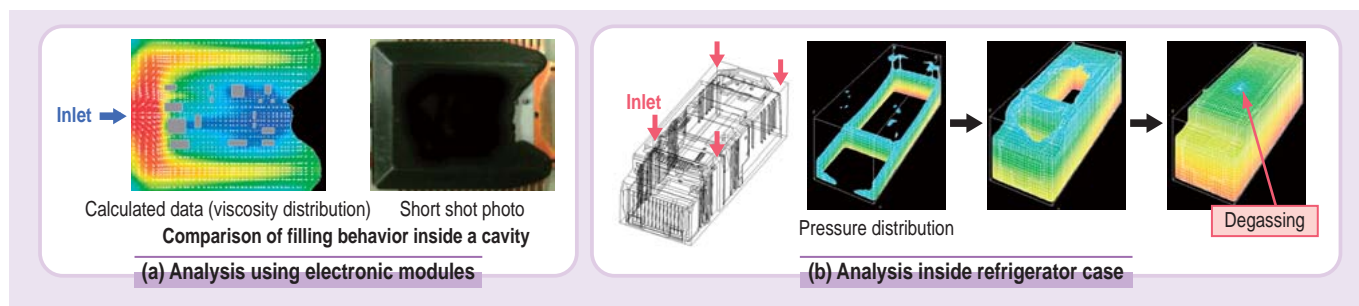

Fluidal behavior analysis in the resin molding process

# Supporting Technology for Product Development to Comply with Environmental Regulations Chemical Substance Management System and Lead-Free Solder Materials/Joining Materials

It is important that the Japanese manufacturing industry comply with European directives aimed at limiting the content in products of six chemical substances, including lead.

In response to that challenge, Hitachi is developing a "Chemical

Substance Management System" that evaluates the chemical substances contained in products and monitors whether their contents are above the regulated levels, and a system of "lead-free solder materials/joining technologies" aimed at eliminating any lead used in solder.

[Main features of chemical substance management system]

(1) Real-time tabulation of purchased components according to a BOM (bill of materials), which describes the parts used in the product.

(2) Evaluation of conformity to regulations, which varies among countries and regions.

(3) Supports design improvements by providing feedback on components and design, and prompts the user to take corrective action if a particular product exhibits non-conformity.

[Main features of lead-free solder materials/joining technologies]

(1) Lead-free solder materials and joining technologies over a broad range of soldering temperatures

(2) High-reliability joining design technology covering various product categories

Hitachi is promoting these programs on a broad basis within the Hitachi Group and offering the resulting packages: "chemical substance management solution" and "lead-free solder joining technologies" to companies and organizations outside Hitachi.

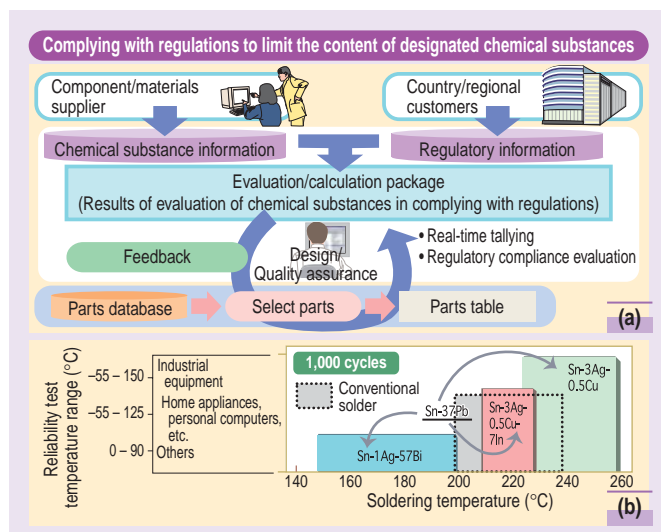

Summary of (a) support system for the control of chemical substances contained in products, and (b) lead-free solder materials/joining technologies